

LiteBee Wing





Brief

- LiteBee Wing is a drone specially designed for STEAM education.
- It's programmable for code learning and extendable for inspiring creativity.



• Appearance •



Materials

ABS+PC



Color

White and Grey



Size

210mmX180mmX50mm



Weight

128g

■ Diagram

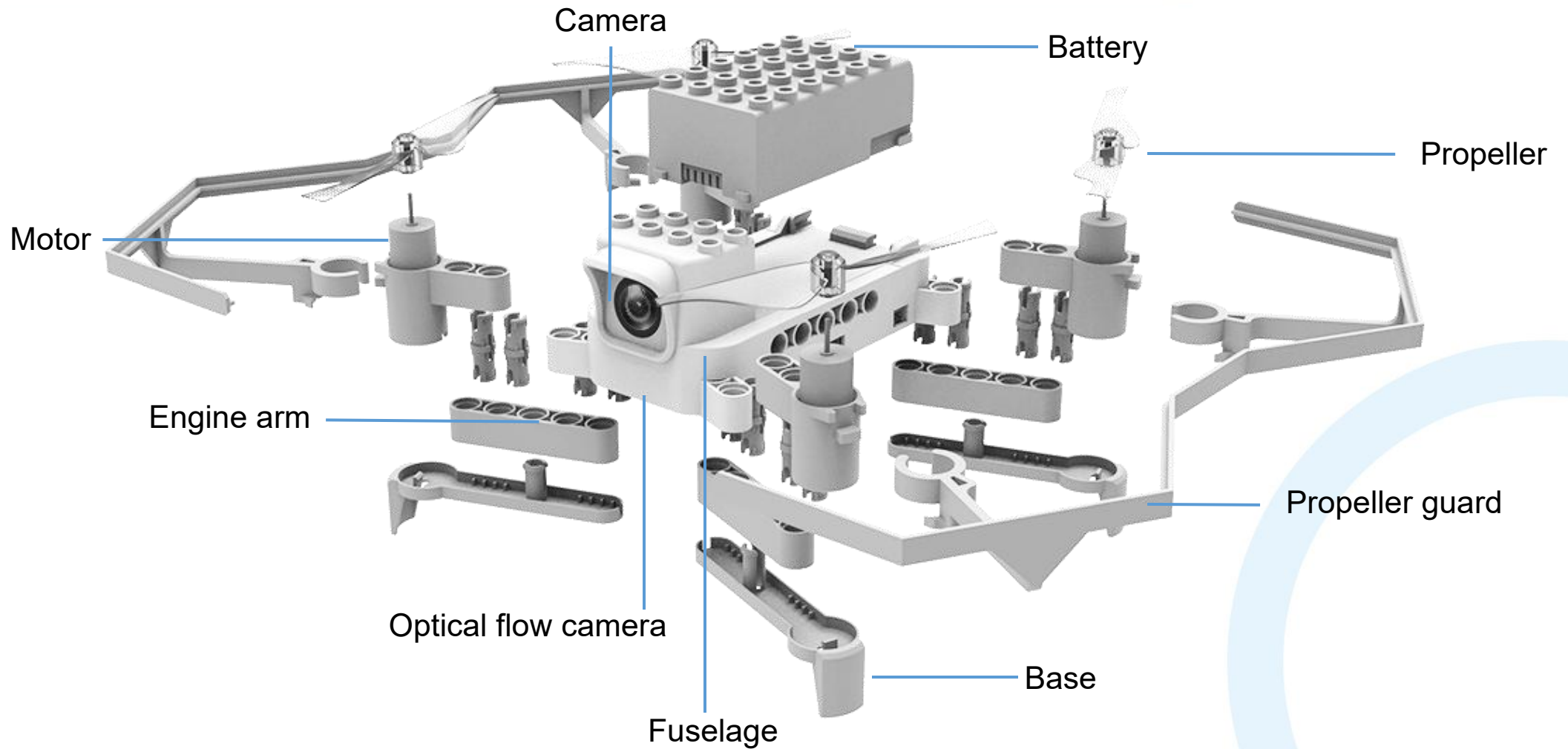

• Flight Performance •



Wheelbase

148mm



Flight Time

10mins



Control Distance

100m



Motor

1020 brushed motor



Environment

indoor

■ Specification

Wheelbase:	148mm	Airscrew:	76mm twin blades
Size:	210mmX180mmX50mm	Charger:	Input:DC5V, Output: DC 8.4V/1.5A
Weight:	128g	Charging Time:	About 1H
Flight Time:	10mins	Application:	LitebeeGo
Battery:	600mAh/2S/7.4V	Control Distance:	100m
Motor:	1020 brushed motor	Program Software:	LitebeeGo



■ Packing List



■ Ways of control ○



Controller

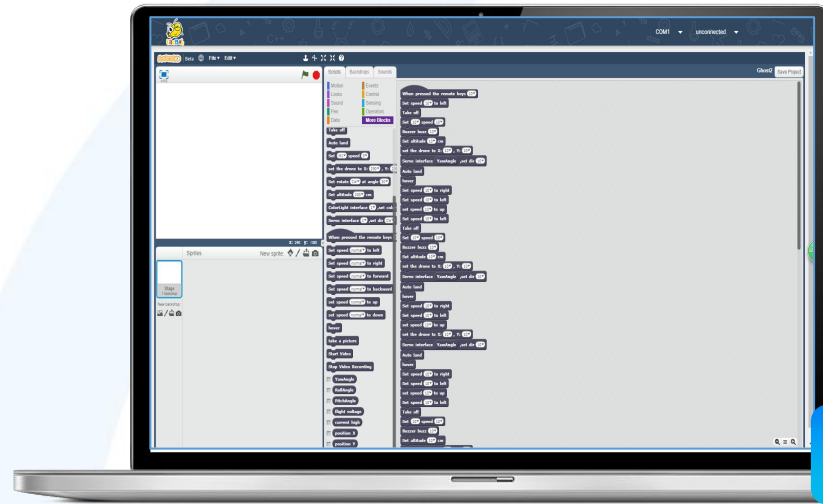

Code

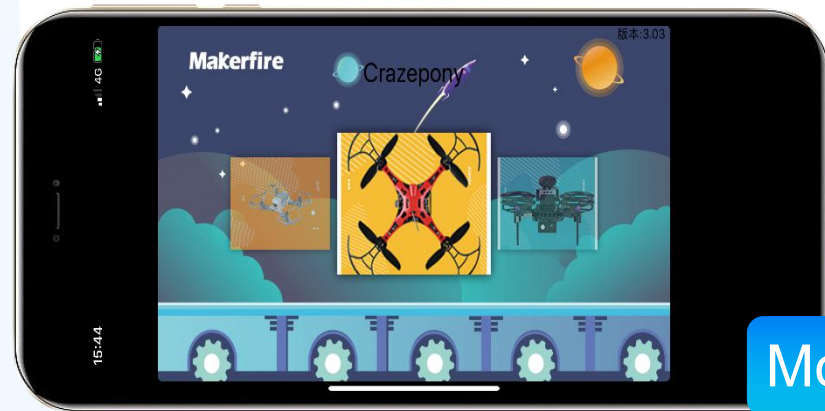

Mobile App

■ Have fun

It could be a cool toy to enjoy spare time

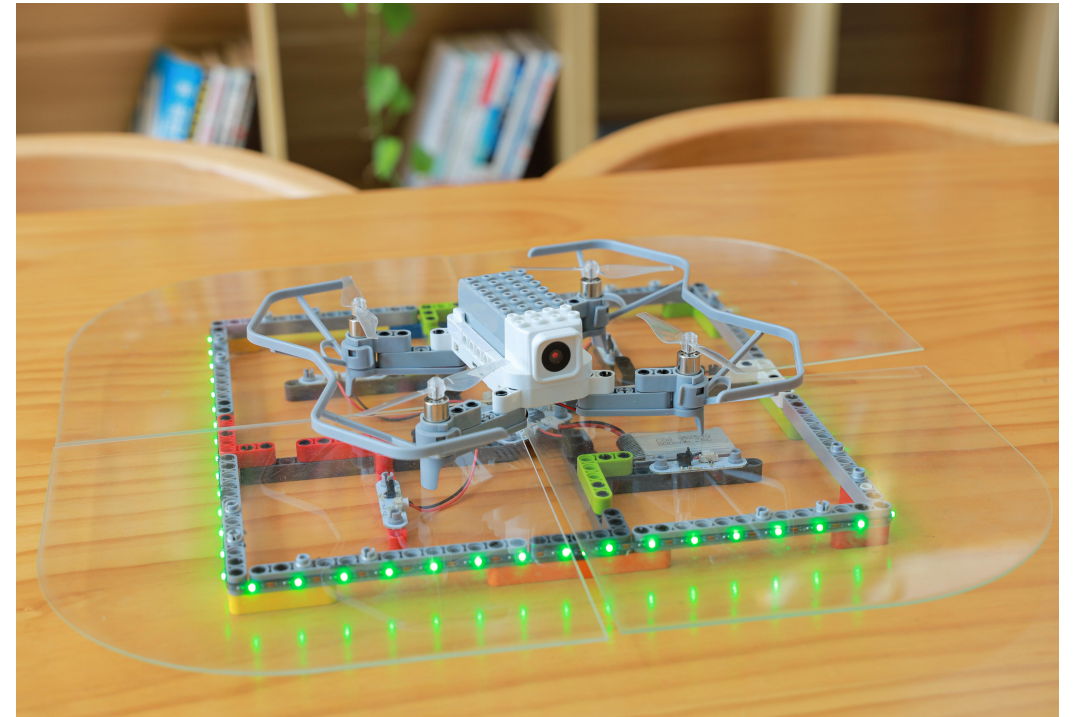



Learn to code

Also could be an enjoyable tool for the student to learn to code, and prepare them for the digital future

3D Flight Preview 3D (Litebee wing FM)

Before you start to fly the formation, you can preview what your code would turn out. That could help to check your code, whether they work or not.



LiteBeeGo

It's a programming software developed by Makerfire, that enables you to program by just dragging the code blocks



Drone swarm (Liebee wing•FM)

You can make an indoor flight formation with LiteBee Wing FM (4 or 10 drones), and fly them as the code you wrote



Recreate with building blocks

LiteBee design the drone's main body with building blocks, which allows you to make a unique drone with extra blocks

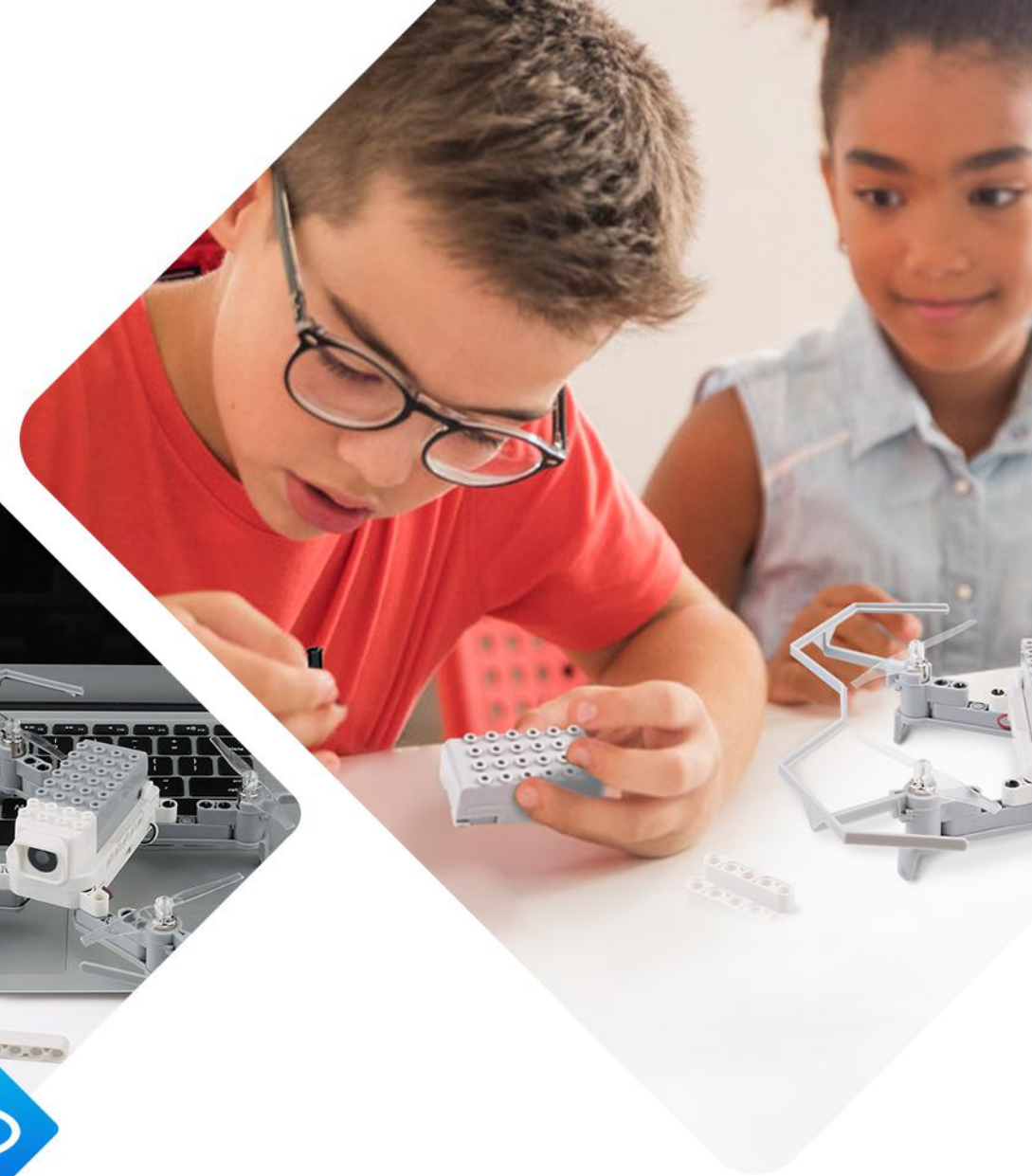

Extensions

Buzzer

RGB light



Electromagnet delivery kit
Robot arm pick kit

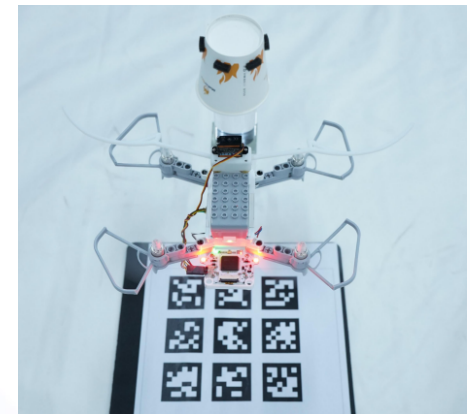
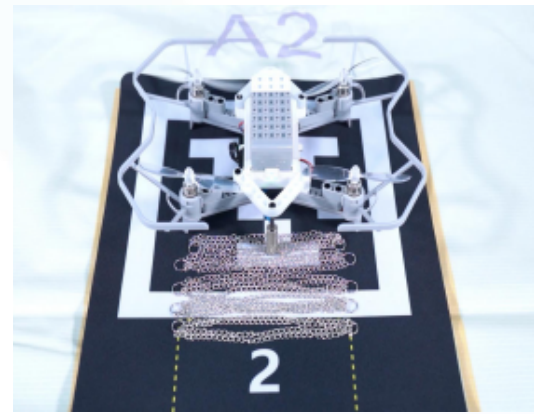

■ Age range of application

	Enlightenment	Beginner	Intermediate	Advanced
Grade	Pro-school	Primary school	Middle school	Higher education
Age	5-7	7-13	13-18	18+
Lesson of Coding	Introductory	Entry-level	Intermediate	Advanced
Benefit	Enjoyable play, inspire curiosity	Skills of hands-on	Inspire creativity	Prepare for digital future
Content	Meet drone, building blocks	Fly the drone, excite interest	Recreate the drone	Develop open-source hardware

■ About Makerfire



Makerfire is a technology-driven company with the business in drones developing, designing, producing, and selling.

In 2016, Makerfire released the first educational drone – LiteBee.

It's the first time to combined STEAM education with the drone successfully.

Up to now, Makerfire has released 4 programmable drones for STEAM education.

With the unique features of programable, composable, extendable, LiteBee gained the leading position in the educational drone.

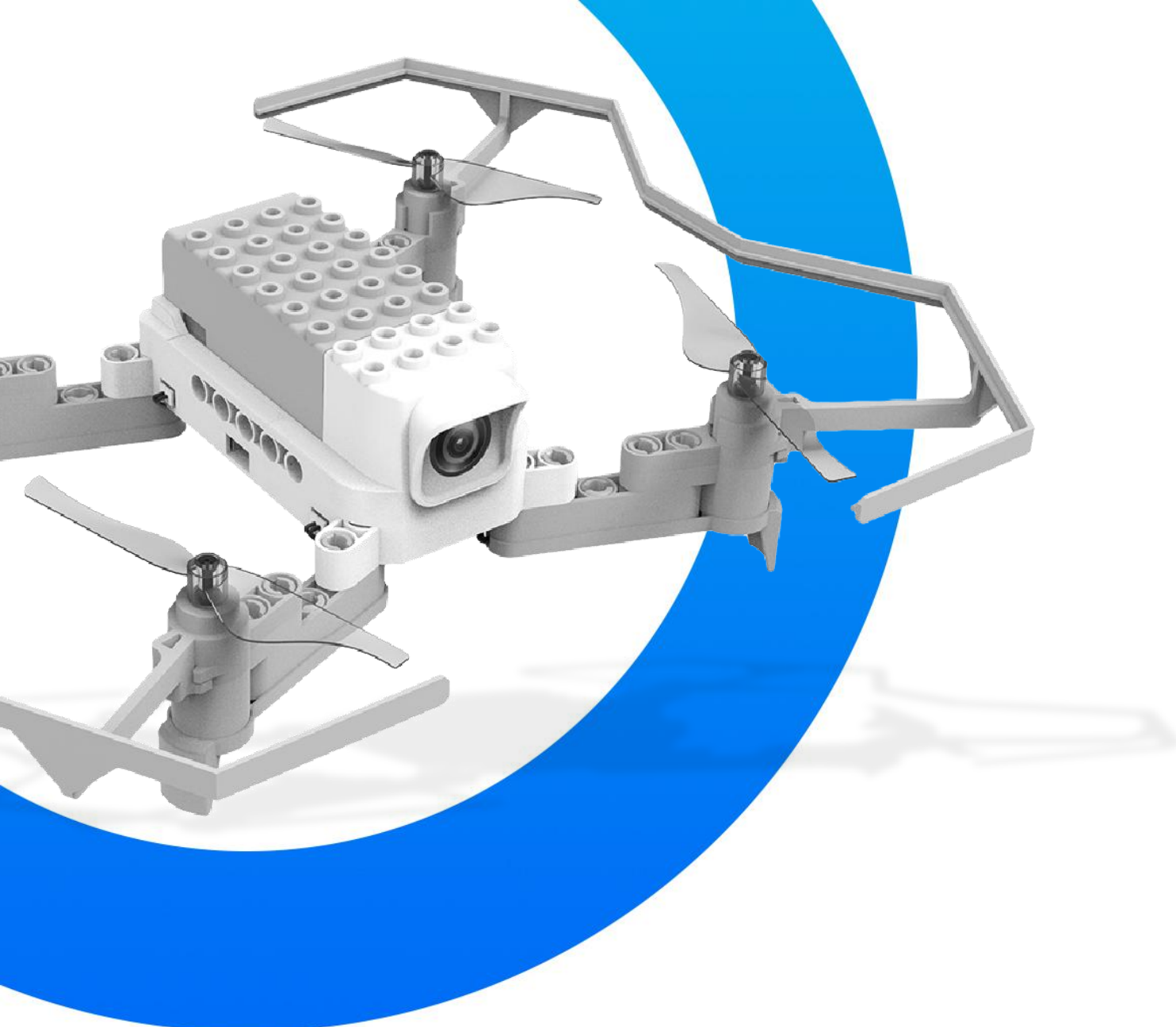

MAKERFIRE

**THANK YOU
FOR YOUR TIME**